

WHITWORTH ADIMLI TRİGER KASNAKLAR

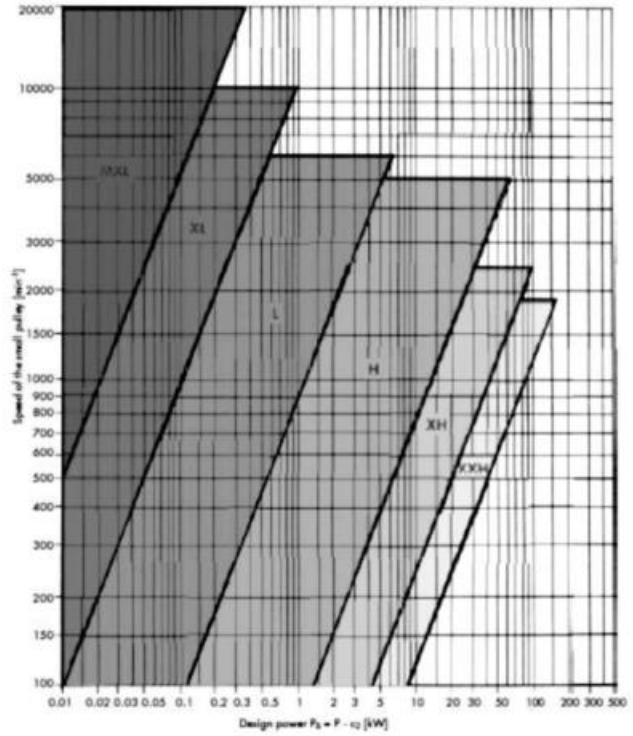

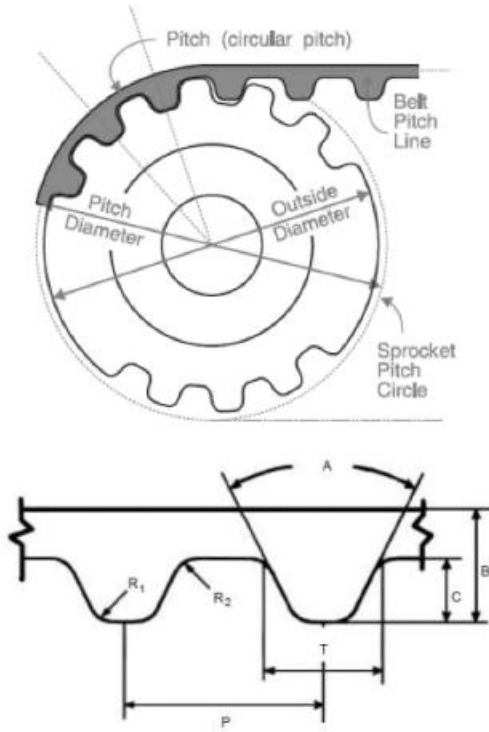

KASNAK PULLEY	A	B	C	T	P	R	R
XL	50°	2,30	1,22	2,57	5,08	0,38	0,04
L	40°	3,60	1,85	4,65	9,53	0,51	0,05
H	40°	3,90	2,18	6,12	12,70	1,02	1,02
XH	40°	4,00	6,22	12,57	22,23	1,19	1,57
XXH	40°	15,20	9,35	19,05	31,75	1,52	2,29

TİP Type	Adım Pitch	
	inç	mm
XL	1/5"	5,080
L	3/8"	9,525
H	1/2"	12,700
XH	7/8"	22,225
XXH	1 1/4"	31,750

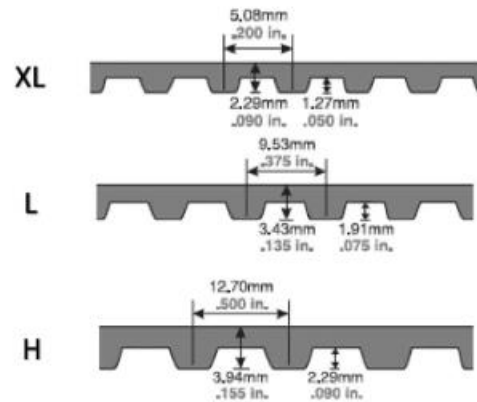

XL 1/5'' (5,08 mm) ADIMLI TRİGER KASNAKLAR

XL 1/5'' (5,08 mm) Pitch Timing Belt Pulleys

Pilot Delikli / Pilot Bore

XL037 Kayış Geniřliđi 6,4mm-9,5mm For Belt Widths 6,4mm and 9,5mm

Diř SAYISI No teeth	ÇAP Diameter		TİP Type	DELİK Bore		BOYUTLAR Dimension		
	P.D. mm	A mm		Min. mm	Max. mm	H mm	F mm	L mm
10	16,17	23	1F	5	5	9,50	14,3	19,8
11	17,79	23	1F	5	5	9,50	14,3	19,8
12	19,40	25	1F	5	8	12,70	14,3	19,8
13	21,02	25	1F	6	8	12,70	14,3	19,8
14	22,64	28	1F	6	9	14,30	14,3	19,8
15	24,26	28	1F	6	11	15,90	14,3	19,8
16	25,87	32	1F	6	2	17,50	14,3	19,8
17	27,49	36	1F	6	13	20,00	14,3	19,8
18	29,11	36	1F	6	13	20,60	14,3	19,8
19	30,72	36	1F	6	13	20,60	14,3	19,8
20	32,34	38	1F	6	15	23,80	14,3	22,2
21	33,96	38	1F	6	15	23,80	14,3	22,2
22	35,57	42	1F	6	16	25,40	14,3	22,2
24	38,81	44	1F	6	18	27,00	14,3	22,2
26	42,04	48	1F	6	20	30,00	14,3	22,2
27	43,66	48	1F	6	20	30,00	14,3	22,2
28	45,28	51	1F	6	20	30,20	14,3	22,2
29	46,89	51	1F	6	20	30,20	14,3	22,2
30	48,51	54	1F	6	24	34,90	14,3	22,2
32	51,74	57	1F	8	25	40,00	14,3	25,4
34	54,98	-	1	8	25	38,00	14,3	25,4
35	56,60	-	1	8	25	38,00	14,3	25,4
36	58,21	-	1	8	30	45,00	14,3	25,4
38	61,45	-	1	8	30	45,00	14,3	25,4
40	64,68	-	1	8	30	45,00	14,3	25,4
42	67,91	-	1	8	30	45,00	14,3	25,4
44	71,15	-	1	8	30	45,00	14,3	25,4
45	72,77	-	1	8	30	45,00	14,3	25,4
48	77,62	-	1	8	30	45,00	14,3	25,4
60	97,02	-	1	8	30	45,00	14,3	25,4
72	116,43	-	1	8	30	45,00	14,3	25,4

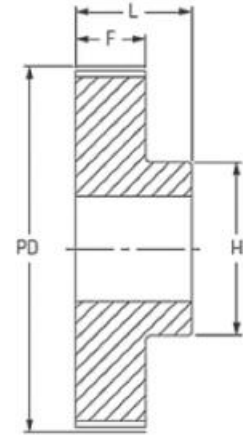

TİP 1 - Type 1

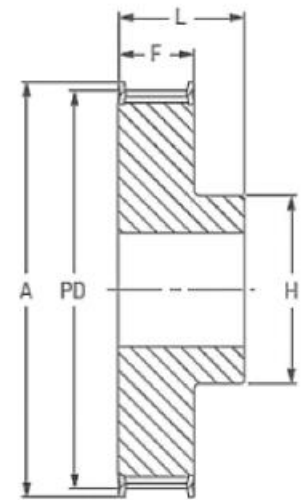

TİP 1F - Type 1F

L 3/8'' (9,525 mm) ADIMLI TRİGER KASNAKLAR

L 3/8'' (9,525 mm) Pitch Timing Belt Pulleys

Pilot Delikli / Pilot Bore

L050 Kayış Geniřliđi 12,7mm For Belt Width 12,7

DİŐ SAYISI No teeth	ÇAP Diameter		TİP Type	DELİK Bore		BOYUTLAR Dimension		
	P.D. mm	A mm		Min. mm	Max. mm	H mm	F mm	L mm
10	30,32	36	1F	6	14	22	19	28
11	33,35	39	1F	6	14	22	19	30
12	36,38	42	1F	6	20	28	19	30
13	39,41	45	1F	6	20	28	19	30
14	42,45	48	1F	8	20	28	19	30
15	45,48	51	1F	8	23	32	19	30
16	48,51	54	1F	8	24	36	19	32
17	51,54	57	1F	10	24	38	19	32
18	54,57	60	1F	10	27	40	19	32
19	57,61	63	1F	10	27	40	19	32
20	60,64	66	1F	10	30	46	19	32
21	63,67	69	1F	10	30	46	19	32
22	66,70	72	1F	10	33	50	19	32
23	69,73	78	1F	10	33	50	19	32
24	72,77	78	1F	12	33	50	19	32
25	75,80	85	1F	12	33	50	19	32
26	78,83	85	1F	12	33	50	19	32
27	81,86	91	1F	12	33	50	19	32
28	84,89	91	1F	12	33	50	19	32
29	87,93	91	1F	12	33	50	19	32
30	90,96	97	1F	12	33	50	19	32
31	93,99	103	1F	12	33	50	19	32
32	97,02	103	1F	12	33	50	19	32
33	100,05	106	1F	12	33	50	19	32
34	103,08	115	1F	12	33	50	19	32
35	106,12	115	1F	12	33	50	19	32
36	109,15	115	1F	12	33	50	19	32
38	115,21	127	1F	12	33	50	19	32
40	121,28	127	1F	12	33	50	19	32
42	127,34	139	1F	12	33	50	19	32
44	133,40	139	1F	12	33	50	19	32
45	136,44	152	1F	12	33	50	19	32
48	145,53	152	1F	12	33	50	19	32
50	151,60	-	5	12	33	50	19	32
52	157,66	-	5	12	33	50	19	32
56	169,79	-	5	12	33	50	19	32
57	172,82	-	5	12	33	50	19	32
60	191,91	-	5	15	45	50	19	42
72	218,3	-	5	15	45	75	19	42
76	230,43	-	5	15	45	75	19	42
84	254,68	-	5	15	45	75	19	42
95	283,03	-	5	15	45	75	19	42
96	291,06	-	5	15	45	75	19	42

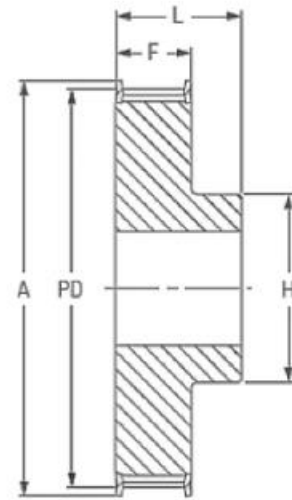

TİP 1F - Type 1F

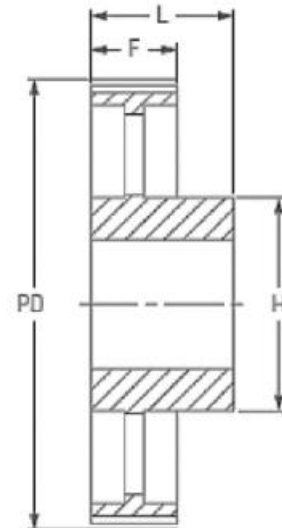

TİP 5 - Type 5

L 3/8" (9,525 mm) ADIMLI TRİGER KASNAKLAR

L 3/8" (9,525 mm) Pitch Timing Belt Pulleys

Pilot Delikli / Pilot Bore

L075 Kayış Geniřlięi 19,1mm For Belt Width 19,1

Dış SAYISI No	ÇAP Diameter		TİP Type	DELİK Bore		BOYUTLAR Dimension		
	P.D. mm	A mm		Min. mm	Max. mm	H mm	F mm	L mm
10	30,32	36	1F	6	14	22	25,4	38
11	33,35	39	1F	6	14	22	25,4	38
12	36,38	42	1F	6	20	28	25,4	38
13	39,41	45	1F	6	20	28	25,4	38
14	42,45	48	1F	8	20	28	25,4	38
15	45,48	51	1F	8	23	32	25,4	38
16	48,51	54	1F	8	24	36	25,4	38
17	51,54	57	1F	10	24	38	25,4	38
18	54,57	60	1F	10	27	40	25,4	38
19	57,61	63	1F	10	27	40	25,4	38
20	60,64	66	1F	10	30	46	25,4	38
21	63,67	69	1F	10	30	46	25,4	38
22	66,70	72	1F	10	33	50	25,4	38
23	69,73	78	1F	10	33	50	25,4	38
24	72,77	78	1F	12	33	50	25,4	38
25	75,80	85	1F	12	33	50	25,4	38
26	78,83	85	1F	12	33	50	25,4	38
27	81,86	91	1F	12	33	50	25,4	38
28	84,89	91	1F	12	33	50	25,4	38
29	87,93	91	1F	12	33	50	25,4	38
30	90,96	97	1F	12	33	50	25,4	38
31	93,99	103	1F	12	33	50	25,4	38
32	97,02	103	1F	12	33	50	25,4	38
33	100,05	106	1F	12	33	50	25,4	38
34	103,08	115	1F	12	33	50	25,4	38
35	106,12	115	1F	12	33	50	25,4	38
36	109,15	115	1F	12	33	50	25,4	38
38	115,21	127	1F	12	33	50	25,4	38
40	121,28	127	1F	12	33	50	25,4	38
42	127,34	139	1F	12	33	50	25,4	38
44	133,40	139	1F	12	33	50	25,4	38
45	136,44	152	1F	12	33	50	25,4	38
48	145,53	152	1F	12	33	50	25,4	38
50	151,60	-	5	12	33	50	25,4	38
52	157,66	-	5	12	33	50	25,4	38
56	169,79	-	5	12	33	50	25,4	38
57	172,82	-	5	12	33	50	25,4	38
60	191,91	-	5	15	45	50	25,4	45
72	218,3	-	5	15	45	75	25,4	45
76	230,43	-	5	15	45	75	25,4	45
84	254,68	-	5	15	45	75	25,4	45
95	283,03	-	5	15	45	75	25,4	45
96	291,06	-	5	15	45	75	25,4	45
120	363,83	-	5	15	70	120	25,4	45

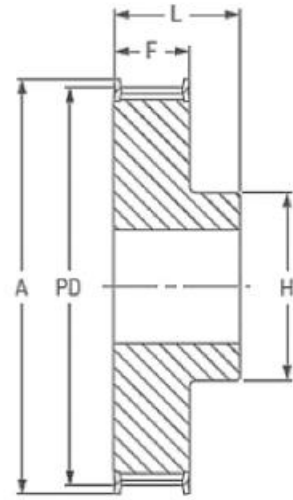

TİP 1F - Type 1F

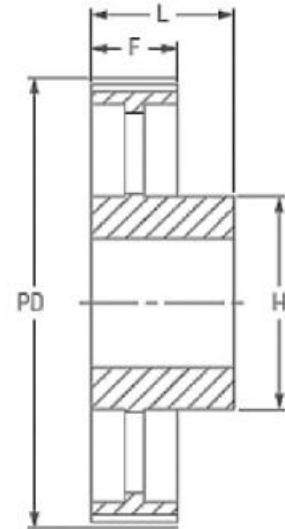

TİP 5 - Type 5

L 3/8" (9,525 mm) ADIMLI TRİGER KASNAKLAR

L 3/8" (9,525 mm) Pitch Timing Belt Pulleys

Pilot Delikli / Pilot Bore

L100 Kayış Geniřlięi 25,4mm For Belt Width 25,4

Diř SAYISI No	ÇAP Diameter		TİP Type	DELİK Bore		BOYUTLAR Dimension		
	P.D. mm	A mm		Min. mm	Max. mm	H mm	F mm	L mm
10	30,32	36	1F	6	14	22	32	45
11	33,35	39	1F	6	14	22	32	45
12	36,38	42	1F	6	20	28	32	45
13	39,41	45	1F	6	20	28	32	45
14	42,45	48	1F	8	20	28	32	45
15	45,48	51	1F	8	23	32	32	45
16	48,51	54	1F	8	24	36	32	45
17	51,54	57	1F	10	24	38	32	45
18	54,57	60	1F	10	27	40	32	45
19	57,61	63	1F	10	27	40	32	45
20	60,64	66	1F	10	30	46	32	45
21	63,67	69	1F	10	30	46	32	45
22	66,70	72	1F	10	33	50	32	45
23	69,73	78	1F	10	33	50	32	45
24	72,77	78	1F	12	33	50	32	45
25	75,80	85	1F	12	33	50	32	45
26	78,83	85	1F	12	33	50	32	45
27	81,86	91	1F	12	33	50	32	45
28	84,89	91	1F	12	33	50	32	45
29	87,93	91	1F	12	33	50	32	45
30	90,96	97	1F	12	33	50	32	45
31	93,99	103	1F	12	33	50	32	45
32	97,02	103	1F	12	33	50	32	45
33	100,05	106	1F	12	33	50	32	45
34	103,08	115	1F	12	33	50	32	45
35	106,12	115	1F	12	33	50	32	45
36	109,15	115	1F	12	33	50	32	45
38	115,21	127	1F	12	33	50	32	45
40	121,28	127	1F	12	33	50	32	45
42	127,34	139	1F	12	33	50	32	45
44	133,40	139	1F	12	33	50	32	45
45	136,44	152	1F	12	33	50	32	45
48	145,53	152	1F	12	33	50	32	45
50	151,60	-	5	12	33	50	32	45
52	157,66	-	5	12	33	50	32	45
56	169,79	-	5	12	33	50	32	45
57	172,82	-	5	12	33	50	32	45
60	191,91	-	5	15	45	50	32	45
72	218,3	-	5	15	45	75	32	45
76	230,43	-	5	15	45	75	32	45
84	254,68	-	5	15	45	75	32	45
95	283,03	-	5	15	45	75	32	45
96	291,06	-	5	15	45	75	32	45
120	363,83	-	5	15	70	120	32	45

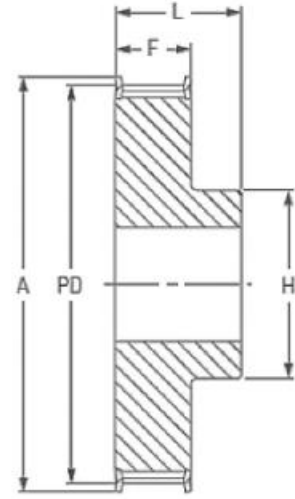

TİP 1F - Type 1F

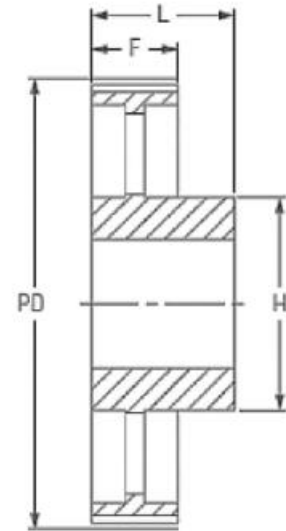

TİP 5 - Type 5

H 1/2" (12,7 mm) ADIMLI TRİGER KASNAKLAR H 1/2" (12,7 mm) Pitch Timing Belt Pulleys Pilot Delikli / Pilot Bore

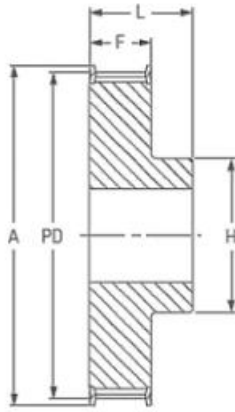

TİP 1F - Type 1F

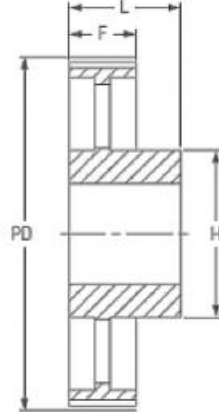

TİP 5 - Type 5

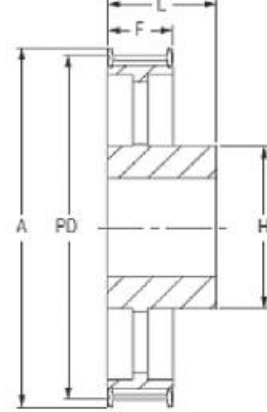

TİP 5F-Type 5F

H075 Kayış Geniřliđi 19,1mm For Belt Width 19,1

DİŐ SAYISI No teeth	ÇAP Diameter		TİP Type	DELİK Bore		BOYUTLAR Dimension		
	P.D. mm	A mm		Min. mm	Max. mm	H mm	F mm	L mm
14	56,60	63	1F	10	27	40	27	40
15	60,64	67	1F	10	30	46	27	40
16	64,68	71	1F	10	30	45	27	40
17	68,72	75	1F	10	30	46	27	40
18	72,77	79	1F	12	36	55	27	40
19	76,81	83	1F	12	40	60	27	40
20	80,85	87	1F	12	41	62	27	40
21	84,89	91	1F	12	43	67	27	40
22	88,94	95	1F	12	45	70	27	40
23	92,98	98	1F	12	46	72	27	40
24	97,02	103	1F	12	47	75	27	40
25	101,06	107	1F	12	47	75	27	40
26	105,11	111	1F	15	54	80	27	40
27	109,15	115	1F	15	54	80	27	40
28	113,19	119	1F	15	54	80	27	40
29	117,23	123	1F	15	54	80	27	40
30	121,28	127	1F	15	54	80	27	40
31	125,32	131	1F	15	54	80	27	40
32	129,36	135	1F	15	54	80	27	40
33	133,40	142	1F	15	54	80	27	40
34	137,45	142	1F	15	54	80	27	40
35	141,49	151	1F	15	54	80	27	40
36	145,53	151	1F	20	54	80	27	40
38	153,62	158	1F	20	54	80	27	40
40	161,70	168	1F	20	54	80	27	40
42	169,79	184	1F	20	54	80	27	40
44	177,87	184	5F	20	54	80	27	40
45	181,91	192	5F	20	54	80	27	40
48	194,04	200	5F	20	54	80	27	40
50	202,13	-	5	20	54	80	27	40

H 1/2'' (12,7 mm) ADIMLI TRİGER KASNAKLAR

H 1/2'' (12,7 mm) Pitch Timing Belt Pulleys

Pilot Delikli / Pilot Bore

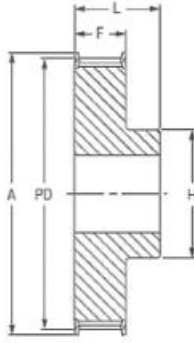

TİP 1F - Type 1F

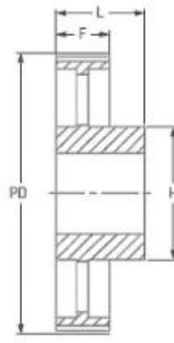

TİP 5 - Type 5

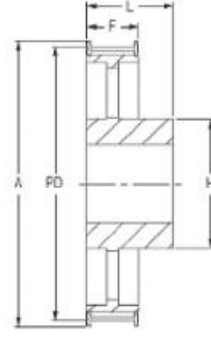

TİP 5F-Type 5F

H100 Kayış Geniřliđi 25,4mm For Belt Width 25,4

DIŐ SAYISI No teeth	ÇAP Diameter		TİP Type	DELİK Bore		BOYUTLAR Dimension		
	P.D. mm	A mm		Min. mm	Max. mm	H mm	F mm	L mm
14	56,60	63	1F	10	27	40	33,3	45
15	60,64	67	1F	10	30	46	33,3	45
16	64,68	71	1F	10	30	45	33,3	45
17	68,72	75	1F	10	30	46	33,3	45
18	72,77	79	1F	12	36	55	33,3	45
19	76,81	83	1F	12	40	60	33,3	45
20	80,85	87	1F	12	41	62	33,3	45
21	84,89	91	1F	12	43	67	33,3	45
22	88,94	95	1F	12	45	70	33,3	45
23	92,98	98	1F	12	46	72	33,3	45
24	97,02	103	1F	12	47	75	33,3	45
25	101,06	107	1F	12	47	75	33,3	45
26	105,11	111	1F	15	54	80	33,3	45
27	109,15	115	1F	15	54	80	33,3	45
28	113,19	119	1F	15	54	80	33,3	45
29	117,23	123	1F	15	54	80	33,3	45
30	121,28	127	1F	15	54	80	33,3	45
31	125,32	131	1F	15	54	80	33,3	45
32	129,36	135	1F	15	54	80	33,3	45
33	133,40	142	1F	15	54	80	33,3	45
34	137,45	142	1F	15	54	80	33,3	45
35	141,49	151	1F	15	54	80	33,3	45
36	145,53	151	1F	20	54	80	33,3	45
38	153,62	158	1F	20	54	80	33,3	45
40	161,70	168	1F	20	54	80	33,3	45
42	169,79	184	1F	20	54	80	33,3	45
44	177,87	184	5F	20	54	80	33,3	50
45	181,91	192	5F	20	54	80	33,3	50
48	194,04	200	5F	20	54	90	33,3	50
50	202,13	-	5	20	54	90	33,3	50
52	210,21	-	5	20	54	90	33,3	50
57	230,42	-	5	20	54	90	33,3	50
58	234,47	-	5	20	54	90	33,3	50
60	242,55	-	5	20	70	120	33,3	50
70	282,98	-	5	20	70	120	33,3	55
72	291,06	-	5	20	70	120	33,3	55
46	307,23	-	5	20	70	120	33,3	55
84	339,57	-	5	20	70	120	33,3	55
96	388,08	-	5	24	70	120	33,3	60
120	485,10	-	5	24	70	120	33,3	60
156	630,63	-	5	24	70	120	33,3	60

H 1/2" (12,7 mm) ADIMLI TRİGER KASNAKLAR

H 1/2" (12,7 mm) Pitch Timing Belt Pulleys

Pilot Delikli / Pilot Bore

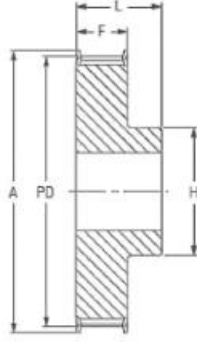

TİP 1F - Type 1F

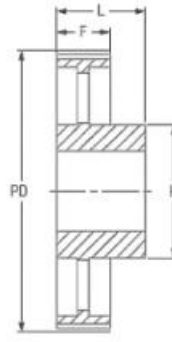

TİP 5 - Type 5

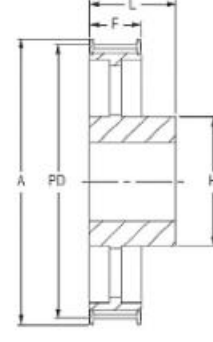

TİP 5F-Type 5F

H150 Kayış Geniřliđi 38,1mm For Belt Width 38,1

DIŐ SAYSISI No teeth	ÇAP Diameter		TİP Type	DELİK Bore		BOYUTLAR Dimension		
	P.D. mm	A mm		Min. mm	Max. mm	H mm	F mm	L mm
14	56,60	63	1F	12	27	40	46	58
15	60,64	67	1F	12	30	46	46	58
16	64,68	71	1F	12	30	46	46	58
17	68,72	75	1F	12	30	46	46	58
18	72,77	79	1F	12	36	55	46	58
19	76,81	83	1F	12	40	60	46	58
20	80,85	87	1F	12	41	62	46	58
21	84,89	91	1F	12	43	67	46	58
22	88,94	95	1F	12	45	70	46	58
23	92,98	98	1F	12	46	72	46	58
24	97,02	103	1F	12	47	75	46	58
25	101,06	107	1F	12	47	75	46	58
26	105,11	111	1F	15	54	80	46	58
27	109,15	115	1F	15	54	80	46	58
28	113,19	119	1F	15	54	80	46	58
29	117,23	123	1F	15	54	80	46	58
30	121,28	127	1F	15	54	80	46	58
31	125,32	131	1F	15	54	80	46	58
32	129,36	135	1F	20	54	80	46	58
33	133,40	142	1F	20	54	80	46	58
34	137,45	142	1F	20	54	80	46	58
35	141,49	151	1F	20	54	80	46	58
36	145,53	151	1F	20	54	80	46	58
38	153,62	158	1F	20	54	80	46	58
40	161,70	168	1F	20	54	80	46	58
42	169,79	184	1F	20	54	80	46	58
44	177,87	184	5F	20	54	80	46	58
45	181,91	192	5F	20	54	80	46	58
48	194,04	200	5F	20	54	90	46	65
50	202,13	-	5	20	54	90	46	65
52	210,21	-	5	20	54	90	46	65
57	230,42	-	5	20	54	90	46	65
58	234,47	-	5	20	54	90	46	65
60	242,55	-	5	20	70	120	46	65
70	282,98	-	5	20	70	120	46	65
72	291,06	-	5	20	70	120	46	65
46	307,23	-	5	20	70	120	46	65
84	339,57	-	5	20	70	120	46	65
96	388,08	-	5	24	70	120	46	65
120	485,10	-	5	24	70	120	46	65
156	630,63	-	5	24	70	120	46	65

H 1/2'' (12,7 mm) ADIMLI TRİGER KASNAKLAR H 1/2'' (12,7 mm) Pitch Timing Belt Pulleys Pilot Delikli / Pilot Bore

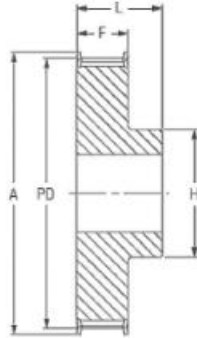

TİP 1F - Type 1F

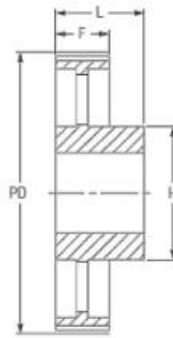

TİP 5 - Type 5

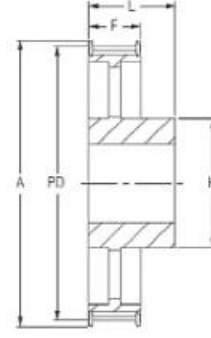

TİP 5F-Type 5F

H200 Kayış Geniřliđi 50,8mm For Belt Width 50,8

DİŐ SAYISI No teeth	ÇAP Diameter		TİP Type	DELİK Bore		BOYUTLAR Dimension		
	P.D. mm	A mm		Min. mm	Max. mm	H mm	F mm	L mm
14	56,60	63	1F	12	27	40	59,5	70
15	60,64	67	1F	12	30	46	59,5	70
16	64,68	71	1F	12	30	46	59,5	70
17	68,72	75	1F	12	30	46	59,5	70
18	72,77	79	1F	12	36	55	59,5	70
19	76,81	83	1F	12	40	60	59,5	70
20	80,85	87	1F	12	41	62	59,5	70
21	84,89	91	1F	12	43	67	59,5	70
22	88,94	95	1F	12	45	70	59,5	70
23	92,98	98	1F	12	46	72	59,5	70
24	97,02	103	1F	12	47	75	59,5	70
25	101,06	107	1F	12	47	75	59,5	70
26	105,11	111	1F	15	54	80	59,5	70
27	109,15	115	1F	15	54	80	59,5	70
28	113,19	119	1F	15	54	80	59,5	70
29	117,23	123	1F	15	54	80	59,5	70
30	121,28	127	1F	15	54	80	59,5	70
31	125,32	131	1F	15	54	80	59,5	70
32	129,36	135	1F	20	54	80	59,5	70
33	133,40	142	1F	20	54	80	59,5	70
34	137,45	142	1F	20	54	80	59,5	70
35	141,49	151	1F	20	54	80	59,5	70
36	145,53	151	1F	20	54	80	59,5	70
38	153,62	158	1F	20	54	80	59,5	70
40	161,70	168	1F	20	54	80	59,5	70
42	169,79	184	1F	20	54	80	59,5	70
44	177,87	184	5F	20	54	80	59,5	70
45	181,91	192	5F	20	54	80	59,5	70
48	194,04	200	5F	20	54	90	59,5	75
50	202,13	-	5	20	54	90	59,5	75
52	210,21	-	5	20	54	90	59,5	75
57	230,42	-	5	20	54	90	59,5	75
58	234,47	-	5	20	54	90	59,5	75
60	242,55	-	5	20	70	120	59,5	75
70	282,98	-	5	20	70	120	59,5	75
72	291,06	-	5	20	70	120	59,5	75
46	307,23	-	5	20	70	120	59,5	75
84	339,57	-	5	20	70	120	59,5	75
96	388,08	-	5	24	70	120	59,5	75
120	485,10	-	5	24	70	120	59,5	75
156	630,63	-	5	24	70	130	59,5	75

H 1/2'' (12,7 mm) ADIMLI TRİGER KASNAKLAR

H 1/2'' (12,7 mm) Pitch Timing Belt Pulleys

Pilot Delikli / Pilot Bore

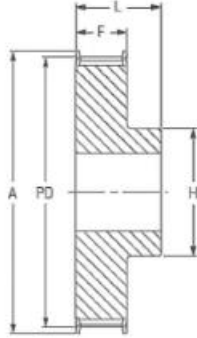

TİP 1F - Type 1F

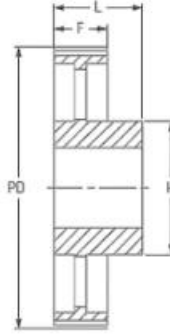

TİP 5 - Type 5

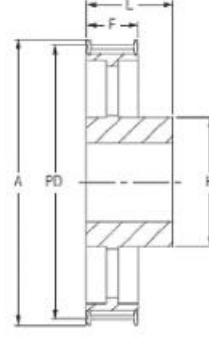

TİP 5F-Type 5F

H300 Kayış Geniřliđi 76,2mm For Belt Width 76,2

DİŐ SAYISI No teeth	ÇAP Diameter		TİP Type	DELİK Bore		BOYUTLAR Dimension		
	P.D. mm	A mm		Min. mm	Max. mm	H mm	F mm	L mm
14	56,60	63	1F	12	27	40	85,5	100
15	60,64	67	1F	12	30	46	85,5	100
16	64,68	71	1F	12	30	46	85,5	100
17	68,72	75	1F	12	30	46	85,5	100
18	72,77	79	1F	12	36	55	85,5	100
19	76,81	83	1F	12	40	60	85,5	100
20	80,85	87	1F	12	41	62	85,5	100
21	84,89	91	1F	12	43	67	85,5	100
22	88,94	95	1F	12	45	70	85,5	100
23	92,98	98	1F	12	46	72	85,5	100
24	97,02	103	1F	12	47	75	85,5	100
25	101,06	107	1F	12	47	75	85,5	100
26	105,11	111	1F	15	54	80	85,5	100
27	109,15	115	1F	15	54	80	85,5	100
28	113,19	119	1F	15	54	80	85,5	100
29	117,23	123	1F	15	54	80	85,5	100
30	121,28	127	1F	15	54	80	85,5	100
31	125,32	131	1F	15	54	80	85,5	100
32	129,36	135	1F	20	54	80	85,5	100
33	133,40	142	1F	20	54	80	85,5	100
34	137,45	142	1F	20	54	80	85,5	100
35	141,49	151	1F	20	54	80	85,5	100
36	145,53	151	1F	20	54	80	85,5	100
38	153,62	158	1F	20	54	80	85,5	100
40	161,70	168	1F	20	54	80	85,5	100
42	169,79	184	1F	20	54	80	85,5	100
44	177,87	184	5F	20	54	80	85,5	100
45	181,91	192	5F	20	54	80	85,5	100
48	194,04	200	5F	20	54	90	85,5	100
50	202,13	-	5	20	54	90	85,5	100
52	210,21	-	5	20	54	90	85,5	100
57	230,42	-	5	20	54	90	85,5	100
58	234,47	-	5	20	54	90	85,5	100
60	242,55	-	5	20	70	120	85,5	100
70	282,98	-	5	20	70	120	85,5	100
72	291,06	-	5	20	70	120	85,5	100
46	307,23	-	5	20	70	120	85,5	100
84	339,57	-	5	20	70	120	85,5	100
96	388,08	-	5	24	70	120	85,5	100
120	485,10	-	5	24	70	120	85,5	100
156	630,63	-	5	24	70	130	85,5	100

XH 7/8'' (22,225 mm) ADIMLI TRİGER KASNAKLAR

XH 7/8'' (22,225 mm) Pitch Timing Belt Pulleys

Pilot Delikli / Pilot Bore

XH 200 Kayış Geniřliđi 50,8mm For Belt Width 50,8

DİŐ SAYISI No teeth	ÇAP Diameter		TİP Type	DELİK Bore		BOYUTLAR Dimension		
	P.D.	A		Min.	Max.	H	F	L
	mm	mm		mm	mm	mm	mm	mm
18	127,34	141	1F	24	67	100	65,1	80
19	134,41	146	1F	24	67	100	65,1	80
20	141,49	155	1F	24	67	100	65,1	80
21	148,56	169	1F	24	73	110	65,1	80
22	155,64	169	1F	24	73	110	65,1	80
24	169,79	183	1F	24	80	120	65,1	80
25	176,86	198	1F	24	80	120	65,1	80
26	183,93	198	1F	24	80	120	65,1	80
27	191,01	212	1F	24	80	120	65,1	80
28	198,09	212	1F	24	80	120	65,1	80
30	212,23	226	1F	24	80	120	65,1	80
32	226,38	240	1F	24	80	120	65,1	80
34	240,53	256	1F	24	80	120	65,1	80
38	268,83	-	5	28	100	150	65,1	80
40	282,98	-	5	28	100	150	65,1	100
48	339,57	-	5	28	100	150	65,1	100
60	424,47	-	5	28	100	150	65,1	100

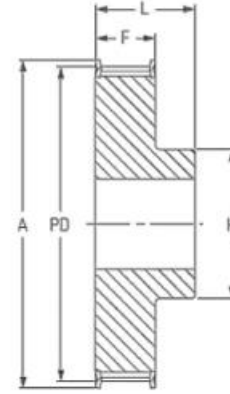

TİP 1F - Type 1F

XH 300 Kayış Geniřliđi 76,2mm For Belt Width 76,2

DİŐ SAYISI No teeth	ÇAP Diameter		TİP Type	DELİK Bore		BOYUTLAR Dimension		
	P.D.	A		Min.	Max.	H	F	L
	mm	mm		mm	mm	mm	mm	mm
18	127,34	141	1F	28	67	100	92,1	110
19	134,41	146	1F	28	67	100	92,1	110
20	141,49	155	1F	28	67	100	92,1	110
21	148,56	169	1F	28	73	110	92,1	110
22	155,64	169	1F	28	73	110	92,1	110
24	169,79	183	1F	28	80	120	92,1	110
25	176,86	198	1F	28	80	120	92,1	110
26	183,93	198	1F	28	80	120	92,1	110
27	191,01	212	1F	28	80	120	92,1	110
28	198,09	212	1F	28	80	120	92,1	110
30	212,23	226	1F	28	80	120	92,1	110
32	226,38	240	1F	28	80	120	92,1	110
34	240,53	256	1F	28	80	120	92,1	110
38	268,83	-	5	32	100	150	92,1	120
40	282,98	-	5	32	100	150	92,1	120
48	339,57	-	5	32	175	150	92,1	120
60	424,47	-	5	32	175	150	92,1	120

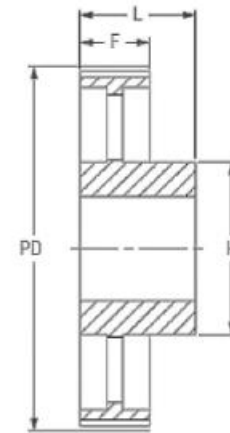

TİP 5 - Type 5

L 3/8'' (9,525 mm) ADIMLI TRİGER KASNAKLAR

L 3/8'' (9,525 mm) Pitch Timing Belt Pulleys

Konik Burçlu / With Taper Bush

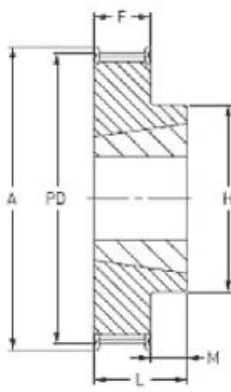

TİP 3F - Type 3F

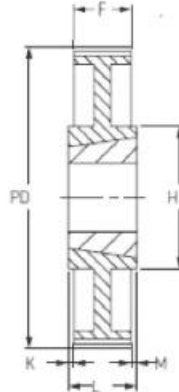

TİP 9 - Type 9

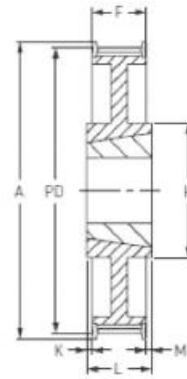

TİP 9F - Type 9F

L050 Kayış Geniřliđi 12,7mm For Belt Width 12,7

DİŐ SAYISI No teeth	ÇAP Diameter		TİP Type	BURÇ Bush	DELİK Bore		BOYUTLAR Dimension				
	P.D.	A			Min.	Max.	H	F	K	L	M
	mm	mm			mm	mm	mm	mm	-	mm	mm
18	54,57	60	3F	1108	10	28	45	19,1	-	22	3
19	57,61	63	3F	1108	10	28	45	19,1	-	22	3
20	60,64	66	3F	1108	10	28	47	19,1	-	22	3
21	63,67	69	3F	1108	10	28	49	19,1	-	22	3
22	66,70	72	3F	1108	10	28	53	19,1	-	22	3
23	69,73	78	3F	1108	10	28	54	19,1	-	22	3
24	72,77	78	3F	1108	10	28	54	19,1	-	22	3
25	75,80	85	3F	1108	10	28	56	19,1	-	22	3
26	78,83	85	3F	1108	10	28	60	19,1	-	22	3
27	81,86	91	3F	1108	10	28	62	19,1	-	22	3
28	84,89	91	3F	1108	10	28	63	19,1	-	22	3
30	90,96	97	3F	1108	10	28	70	19,1	-	22	3
32	97,02	103	3F	1108	10	28	74	19,1	-	22	3
36	109,15	115	3F	1108	10	28	85	19,1	-	22	3
40	121,28	127	3F	1610	13	42	90	19,1	-	25	6
42	127,34	139	3F	1610	13	42	90	19,1	-	25	6
44	133,40	139	3F	1610	13	42	92	19,1	-	25	6
48	145,53	152	9F	1610	13	42	92	19,1	-	25	3
60	191,91	-	9	1610	13	42	92	19,1	3	25	3
72	218,3	-	9	1610	13	42	92	19,1	3	25	3
84	254,68	-	9	1610	13	42	92	19,1	3	25	3
96	291,06	-	9	2012	19	50	111	19,1	6,5	32	6,5
120	363,83	-	9	2012	19	50	111	19,1	6,5	32	6,5

L 3/8" (9,525 mm) ADIMLI TRİGER KASNAKLAR

L 3/8" (9,525 mm) Pitch Timing Belt Pulleys

Konik Burçlu / With Taper Bush

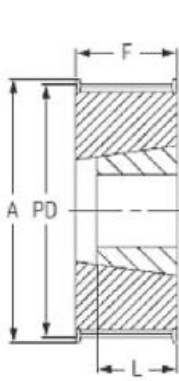

TİP 2F - Type 2F

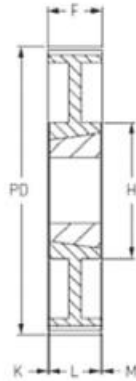

TİP 7 - Type 7

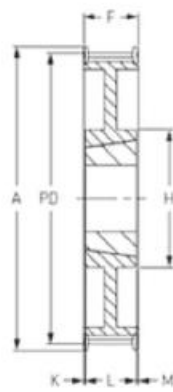

TİP 7F - Type 7F

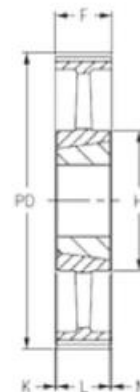

TİP 8 - Type 8

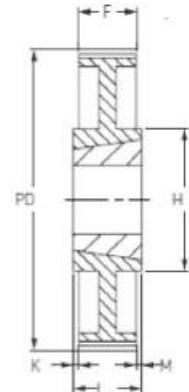

TİP 9 - Type 9

L075

Kayış Geniřlięi 19,1mm For Belt Width 19,1

Diř SAYISI No teeth	ÇAP Diameter		TİP Type	BURÇ Bush	DELİK Bore		BOYUTLAR Dimension				
	P.D. mm	A mm			Min. mm	Max. mm	H mm	F mm	K mm	L mm	M mm
18	54,57	60	2F	1108	10	28	-	25,4	-	25,4	-
19	57,61	63	2F	1108	10	28	-	25,4	-	25,4	-
20	60,64	66	2F	1108	10	28	-	25,4	-	25,4	-
21	63,67	69	2F	1108	10	28	-	25,4	-	25,4	-
22	66,70	72	2F	1108	10	28	-	25,4	-	25,4	-
23	69,73	78	2F	1108	10	28	-	25,4	-	25,4	-
24	72,77	78	2F	1108	10	28	-	25,4	-	25,4	-
25	75,80	85	2F	1108	10	28	-	25,4	-	25,4	-
26	78,83	85	2F	1108	10	28	-	25,4	-	25,4	-
27	81,86	91	2F	1108	10	28	-	25,4	-	25,4	-
28	84,89	91	2F	1108	10	28	-	25,4	-	25,4	-
30	90,96	97	2F	1108	10	28	-	25,4	-	25,4	-
32	97,02	103	2F	1108	10	28	-	25,4	-	25,4	-
36	109,15	115	2F	1610	13	42	-	25,4	-	25,4	-
40	121,28	127	2F	1610	13	42	-	25,4	-	25,4	-
42	127,34	139	2F	1610	13	42	-	25,4	-	25,4	-
44	133,40	139	2F	1610	13	42	-	25,4	-	25,4	-
48	145,53	152	7F	1610	13	42	92	25,4	-	25	-
60	191,91	-	7	1610	13	42	92	25,4	-	25	-
72	218,3	-	8	1610	13	42	92	25,4	-	25	-
84	254,68	-	9	2012	19	50	111	25,4	3,5	32	3,5
96	291,06	-	9	2012	19	50	111	25,4	3,5	32	3,5
120	363,83	-	9	2012	19	50	111	25,4	3,5	32	3,5

L 3/8" (9,525 mm) ADIMLI TRİGER KASNAKLAR

L 3/8" (9,525 mm) Pitch Timing Belt Pulleys

Konik Burçlu / With Taper Bush

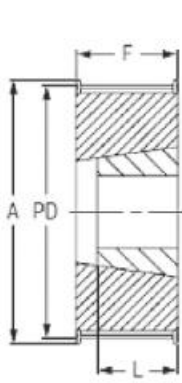

TİP 2F - Type 2F

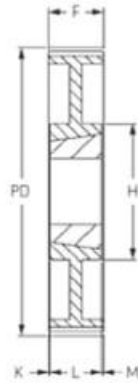

TİP 7 - Type 7

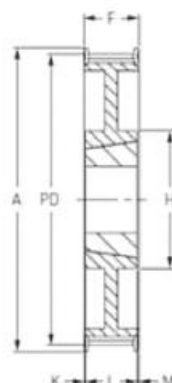

TİP 7F - Type 7F

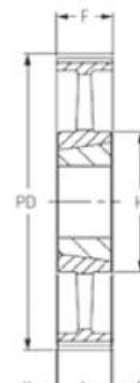

TİP 8 - Type 8

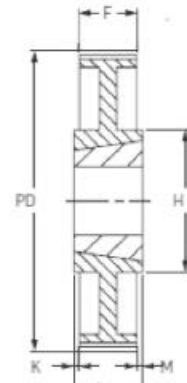

TİP 9 - Type 9

L100

Kayış Geniřlięi 25,4mm For Belt Width 25,4

DİŐ SAYISI No teeth	ÇAP Diameter		TİP Type	BURÇ Bush	DELİK Bore		BOYUTLAR Dimension				
	P.D.	A			Min.	Max.	H	F	K	L	M
	mm	mm			mm	mm	mm	mm	-	mm	mm
18	54,57	60	2F	1108	10	28	-	25,4	-	25,4	-
19	57,61	63	2F	1108	10	28	-	25,4	-	25,4	-
20	60,64	66	2F	1108	10	28	-	25,4	-	25,4	-
21	63,67	69	2F	1108	10	28	-	25,4	-	25,4	-
22	66,70	72	2F	1108	10	28	-	25,4	-	25,4	-
23	69,73	78	2F	1108	10	28	-	25,4	-	25,4	-
24	72,77	78	2F	1108	10	28	-	25,4	-	25,4	-
25	75,80	85	2F	1108	10	28	-	25,4	-	25,4	-
26	78,83	85	2F	1108	10	28	-	25,4	-	25,4	-
27	81,86	91	2F	1108	10	28	-	25,4	-	25,4	-
28	84,89	91	2F	1108	10	28	-	25,4	-	25,4	-
30	90,96	97	2F	1108	10	28	-	25,4	-	25,4	-
32	97,02	103	2F	1108	10	28	-	25,4	-	25,4	-
36	109,15	115	2F	1610	13	42	-	25,4	-	25,4	-
40	121,28	127	2F	1610	13	42	-	25,4	-	25,4	-
42	127,34	139	2F	1610	13	42	-	25,4	-	25,4	-
44	133,40	139	2F	1610	13	42	-	25,4	-	25,4	-
48	145,53	152	7F	1610	13	42	92	25,4	-	25	-
60	191,91	-	7	1610	13	42	92	25,4	-	25	-
72	218,3	-	8	1610	13	42	92	25,4	-	25	-
84	254,68	-	9	2012	19	50	111	25,4	3,5	32	3,5
96	291,06	-	9	2012	19	50	111	25,4	3,5	32	3,5
120	363,83	-	9	2012	19	50	111	25,4	3,5	32	3,5

H 1/2'' (12,7 mm) ADIMLI TRİGER KASNAKLAR

H 1/2'' (12,7 mm) Pitch Timing Belt Pulleys

Konik Burçlu / With Taper Bush

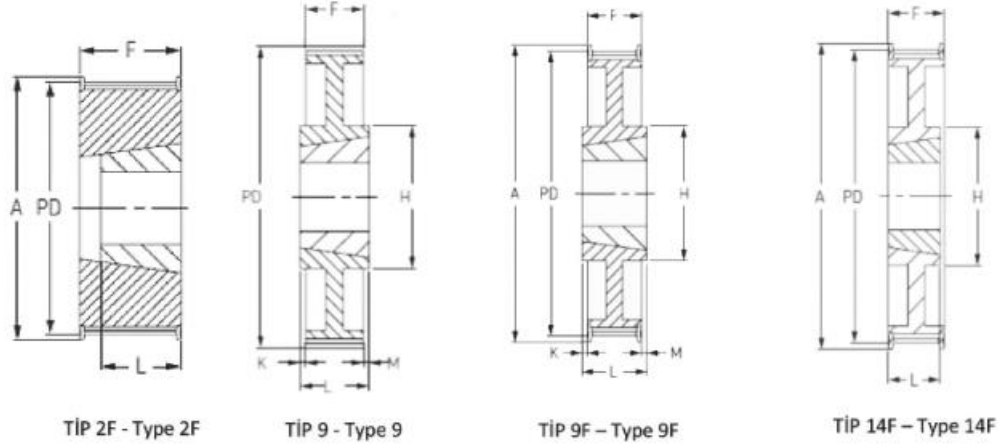

H 075

Kayış Geniřlięi 19,1mm For Belt Width 19,1

Diř SAYISI No teeth	ÇAP Diameter		TİP Type	BURÇ Bush	DELİK Bore		BOYUTLAR Dimension				
	P.D.	A			Min.	Max.	H	F	K	L	M
	mm	mm			mm	mm	mm	mm	mm	mm	mm
14	56,60	63	2F	1108	10	28	-	27		22	
15	60,64	67	2F	1108	10	28	-	27		22	
16	64,68	71	2F	1108	10	28	-	27		22	
17	68,72	75	2F	1108	10	28	-	27		22	
18	72,77	79	2F	1210	11	32	-	27		25	
19	76,81	83	2F	1210	11	32	-	27		25	
20	80,85	87	2F	1210	11	32	-	27		25	
21	84,89	91	2F	1210	11	32	-	27		25	
22	88,94	95	2F	1210	11	32	-	27		25	
23	92,98	98	2F	1610	13	42	-	27		25	
24	97,02	103	2F	1610	13	42	-	27		25	
25	101,06	107	2F	1610	13	42	-	27		25	
26	105,11	111	2F	1610	13	42	-	27		25	
27	109,15	115	2F	1610	13	42	-	27		25	
28	113,19	119	2F	1610	13	42	-	27		25	
29	117,23	123	2F	1610	13	42	-	27		25	
30	121,28	127	2F	1610	13	42	-	27		25	
32	129,36	135	14F	1610	13	42	92	27		25	
33	133,40	142	14F	1610	13	42	92	27		25	
34	137,45	142	14F	1610	13	42	92	27		25	
35	141,49	151	14F	1610	13	42	92	27		25	
36	145,53	151	14F	1610	13	42	92	27		25	
38	153,62	158	14F	1610	13	42	92	27		25	
40	161,70	168	14F	1610	13	42	92	27		25	
44	177,87	184	9F	2012	14	50	106	27	2,5	32	2,5
48	194,04	200	9F	2012	14	50	106	27	2,5	32	2,5
60	242,55	-	9	2012	14	50	106	27	2,5	32	2,5
72	291,06	-	9	2012	14	50	112	27	2,5	32	2,5
84	339,57	-	9	2012	14	50	112	27	2,5	32	2,5
96	388,08	-	9	2517	16	60	125	27	9	45	9
120	485,10	-	9	2517	16	60	125	27	9	45	9

H 1/2'' (12,7 mm) ADIMLI TRİGER KASNAKLAR

H 1/2'' (12,7 mm) Pitch Timing Belt Pulleys

Konik Burçlu / With Taper Bush

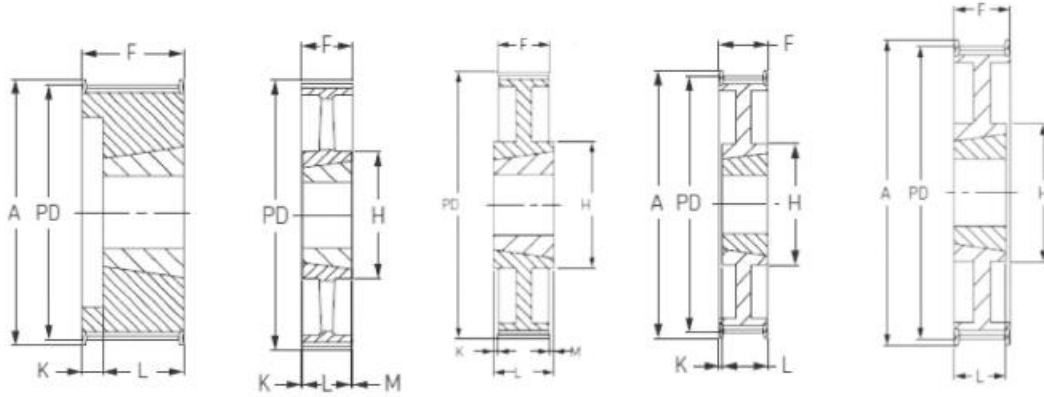

TİP 4F - Type 4F

TİP 8 - Type 8

TİP 9 - Type 9

TİP 13F - Type 13F

TİP 14F - Type 14F

H 100

Kayış Geniřlięi 25,4mm For Belt Width 25,4

DİŐ SAYISI No teeth	ÇAP Diameter		TİP Type	BURÇ Bush	DELİK Bore		BOYUTLAR Dimension				
	P.D.	A			Min.	Max.	H	F	K	L	M
	mm	mm			mm	mm	mm	mm	mm	mm	mm
14	56,60	63	4F	1108	10	28	-	31	9	22	
15	60,64	67	4F	1108	10	28	-	31	9	22	
16	64,68	71	4F	1108	10	28	-	31	9	22	
17	68,72	75	4F	1108	10	28	-	31	9	22	
18	72,77	79	4F	1210	11	32	-	31	6	25	
19	76,81	83	4F	1210	11	32	-	31	6	25	
20	80,85	87	4F	1210	11	32	-	31	6	25	
21	84,89	91	4F	1210	11	32	-	31	7	25	
22	88,94	95	4F	1210	11	32	-	31	7	25	
23	92,98	98	4F	1610	13	42	-	31	7	25	
24	97,02	103	4F	1610	13	42	-	31	7	25	
25	101,06	107	4F	1610	13	42	-	31	7	25	
26	105,11	111	4F	1610	13	42	-	31	7	25	
27	109,15	115	4F	1610	13	42	-	31	7	25	
28	113,19	119	4F	1610	13	42	-	31	7	25	
29	117,23	123	4F	1610	13	42	-	31	7	25	
30	121,28	127	4F	1610	13	42	-	31	7	25	
32	129,36	135	13F	1610	13	42	92	31	7	25	
36	145,53	151	13F	1610	13	42	92	31	7	25	
40	161,70	168	13F	1610	13	42	92	31	7	25	
44	177,87	184	14F	2012	14	50	106	31	7	32	
48	194,04	200	14F	2012	14	50	106	31	7	32	
60	242,55	-	8	2012	14	50	106	31	1	32	1
72	291,06	-	8	2012	14	50	112	31	1	32	1
84	339,57	-	8	2012	14	50	112	31	1	32	1
96	388,08	-	9	2517	16	60	125	31	5,5	45	5,5

H 1/2'' (12,7 mm) ADIMLI TRİGER KASNAKLAR

H 1/2'' (12,7 mm) Pitch Timing Belt Pulleys

Konik Burçlu / With Taper Bush

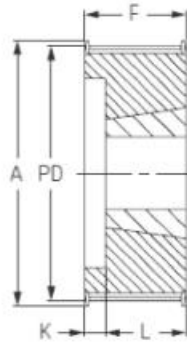

TİP 4F - Type 4F

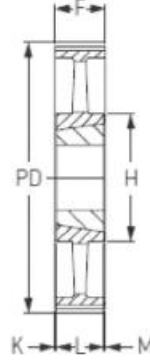

TİP 8 - Type 8

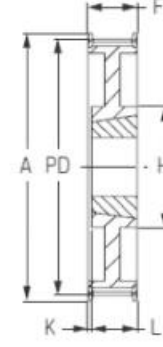

TİP 13F - Type 13F

H 150

Kayış Geniřlięi 38,1mm For Belt Width 38,1

DİŐ SAYISI No teeth	ÇAP Diameter		TİP Type	BURÇ Bush	DELİK Bore		BOYUTLAR Dimension				
	P.D. mm	A mm			Min. mm	Max. mm	H mm	F mm	K mm	L mm	M mm
14	56,60	63	4F	1108	10	28	-	45	23	22	
15	60,64	67	4F	1108	10	28	-	45	23	22	
16	64,68	71	4F	1210	10	28	-	45	20	25	
17	68,72	75	4F	1210	10	28	-	45	20	25	
18	72,77	79	4F	1210	11	32	-	45	20	25	
19	76,81	83	4F	1210	11	32	-	45	20	25	
20	80,85	87	4F	1210	11	32	-	45	20	25	
21	84,89	91	4F	1210	11	32	-	45	20	25	
22	88,94	95	4F	1210	11	32	-	45	20	25	
23	92,98	98	4F	1610	13	42	-	45	20	25	
24	97,02	103	4F	1610	13	42	-	45	20	25	
25	101,06	107	4F	1610	13	42	-	45	20	25	
26	105,11	111	4F	1610	13	42	-	45	20	25	
27	109,15	115	4F	1610	13	42	-	45	20	25	
28	113,19	119	4F	1610	13	42	-	45	20	25	
29	117,23	123	4F	1610	13	42	-	45	20	25	
30	121,28	127	4F	1610	13	42	-	45	20	25	
32	129,36	135	13F	1610	13	42	92	45	20	25	
36	145,53	151	13F	1610	13	42	92	45	20	25	
40	161,70	168	13F	1610	13	42	92	45	20	25	
44	177,87	184	14F	2012	14	50	106	45	13	32	
48	194,04	200	14F	2012	14	50	106	45	13	32	
60	242,55	-	8	2012	14	50	106	45	7	32	7
72	291,06	-	8	2012	14	50	112	45	7	32	7
84	339,57	-	8	2012	14	50	112	45	7	32	7
96	388,08	-	8	2517	16	60	125	45	0,5	45	0,5
120	485,10	-	8	2517	16	60	125	45	0,5	45	0,5

H 1/2" (12,7 mm) ADIMLI TRİGER KASNAKLAR

H 1/2" (12,7 mm) Pitch Timing Belt Pulleys

Konik Burçlu / With Taper Bush

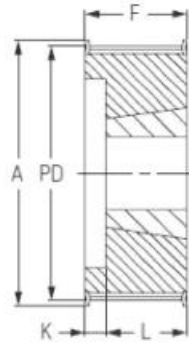

TİP 4F - Type 4F

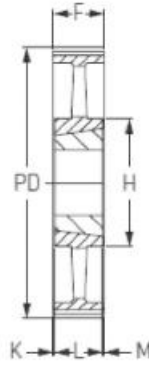

TİP 8 - Type 8

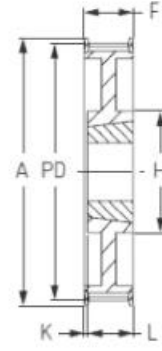

TİP 13F - Type 13F

H 200

Kayış Genişliği 50,8mm For Belt Width 50,8

Diş SAYISI No teeth	ÇAP Diameter		TİP Type	BURÇ Bush	DELİK Bore		BOYUTLAR Dimension				
	P.D. mm	A mm			Min. mm	Max. mm	H mm	F mm	K mm	L mm	M mm
16	64,68	71	4F	1108	10	28	-	58	36	22	
17	68,72	75	4F	1210	10	28	-	58	33	25	
18	72,77	79	4F	1210	11	32	-	58	33	25	
19	76,81	83	4F	1610	13	42	-	58	33	25	
20	80,85	87	4F	1610	13	42	-	58	33	25	
21	84,89	91	4F	1610	13	42	-	58	33	25	
22	88,94	95	4F	1610	13	42	-	58	33	25	
23	92,98	98	4F	1610	13	42	-	58	33	25	
24	97,02	103	4F	1610	13	42	-	58	33	25	
25	101,06	107	4F	1610	13	42	-	58	33	25	
26	105,11	111	4F	1610	13	42	-	58	33	25	
27	109,15	115	4F	1610	13	42	-	58	33	25	
28	113,19	119	4F	1610	13	42	-	58	33	25	
29	117,23	123	4F	1610	13	42	-	58	33	25	
30	121,28	127	4F	1610	13	42	-	58	33	25	
32	129,36	135	4F	2012	14	50	-	58	26	32	
36	145,53	151	13F	2012	14	50	106	58	26	32	
40	161,70	168	13F	2012	14	50	106	58	26	32	
44	177,87	184	13F	2012	14	50	106	58	26	32	
48	194,04	200	13F	2517	16	60	125	58	13	45	
60	242,55	-	8	2517	16	60	125	60	7,5	45	7,5
72	291,06	-	8	2517	16	60	125	60	7,5	45	7,5
84	339,57	-	8	2517	16	60	125	60	7,5	45	7,5
96	388,08	-	8	2517	16	60	125	60	7,5	45	7,5
120	485,10	-	8	2517	16	60	125	60	7,5	45	7,5

H 1/2'' (12,7 mm) ADIMLI TRİGER KASNAKLAR

H 1/2'' (12,7 mm) Pitch Timing Belt Pulleys

Konik Burçlu / With Taper Bush

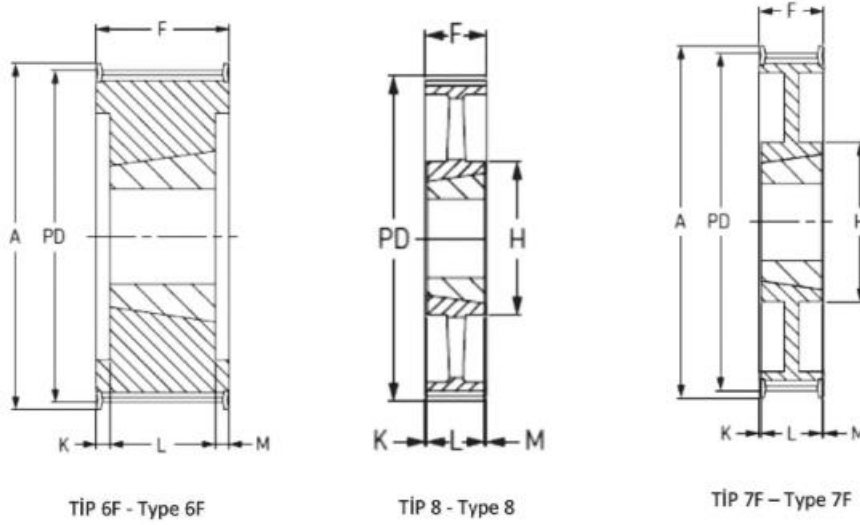

H 300

Kayış Geniřlięi 76,2mm For Belt Width 76,2

DIŐ SAYISI No teeth	ÇAP Diameter		TİP Type	BURÇ Bush	DELİK Bore		BOYUTLAR Dimension				
	P.D. mm	A mm			Min. mm	Max. mm	H mm	F mm	K mm	L mm	M mm
18	72,77	79	6F	1215	11	32	-	84	23	38	23
20	80,85	87	6F	1615	13	42	-	84	23	38	23
21	84,89	91	6F	1615	13	42	-	84	23	38	23
22	88,94	95	6F	1615	13	42	-	84	23	38	23
23	92,98	98	6F	1615	13	42	-	84	23	38	23
24	97,02	103	6F	1615	13	42	-	84	23	38	23
25	101,06	107	6F	1615	13	42	-	84	23	38	23
26	105,11	111	6F	1615	13	42	-	84	23	38	23
27	109,15	115	6F	2012	14	50	-	84	26	32	26
28	113,19	119	6F	2012	14	50	-	84	26	32	26
30	121,28	127	6F	2012	14	50	-	84	26	32	26
32	129,36	135	6F	2517	16	60	-	84	19,5	45	19,5
36	145,53	151	6F	2517	16	60	-	84	19,5	45	19,5
40	161,70	168	6F	2517	16	60	-	84	19,5	45	19,5
44	177,87	184	7F	2517	16	60	125	86	20,5	45	20,5
48	194,04	200	7F	2517	16	60	125	86	20,5	45	20,5
60	242,55	-	8	2517	16	60	125	86	20,5	45	20,5
72	291,06	-	8	2517	16	60	125	86	20,5	45	20,5
84	339,57	-	8	2517	16	60	125	86	20,5	45	20,5
96	388,08	-	8	3030	32	75	170	86	5	76	5
120	485,10	-	8	3030	32	75	170	86	5	76	5

XH 7/8'' (22,225 mm) ADIMLI TRİGER KASNAKLAR

XH 7/8'' (22,225mm) Pitch Timing Belt Pulleys

Konik Burçlu / With Taper Bush

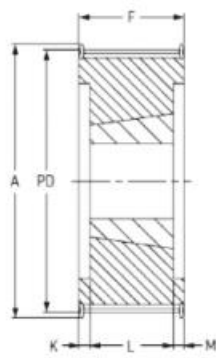

TİP 6F - Type 6F

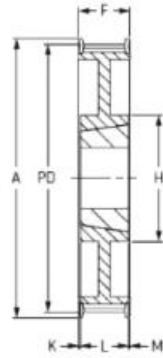

TİP 7F - Type 7F

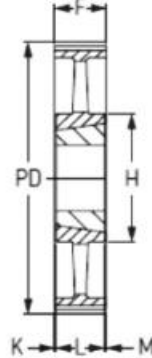

TİP 8 - Type 8

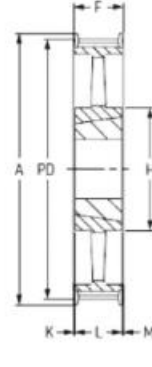

TİP 8F - Type 8F

XH 200

Kayış Geniřliđi 50,8mm For Belt Width 50,8

DİŐ SAYISI No teeth	ÇAP Diameter		TİP Type	BURÇ Bush	DELİK Bore		BOYUTLAR Dimension				
	P.D.	A			Min.	Max.	H	K	F	L	M
	mm	mm			mm	mm	mm	mm	mm	mm	mm
18	127,34	141	6F	2012	14	50	-	-	65,1	32	-
19	134,41	146	6F	2012	14	50	-	-	65,1	32	-
20	141,49	155	6F	2012	14	50	-	-	65,1	32	-
21	148,56	169	6F	2517	16	60	-	-	65,1	45	-
22	155,64	169	6F	2517	16	60	-	-	65,1	45	-
24	169,79	183	6F	2517	16	60	-	-	65,1	45	-
25	176,86	198	6F	2517	16	60	-	-	65,1	45	-
26	183,93	198	6F	2517	16	60	-	-	65,1	45	-
27	191,01	212	7F	2517	16	60	120	10	65,1	45	10
28	198,09	212	7F	2517	16	60	120	10	65,1	45	10
30	212,23	226	7F	2517	16	60	120	10	65,1	45	10
32	226,38	240	7F	2517	16	60	120	10	65,1	45	10
36	254,64	267	8F	2517	16	60	120	10	65,1	45	10
40	282,98	-	8	3020	25	75	170	7	65,1	51	7
48	339,57	-	8	3020	25	75	170	7	65,1	51	7
60	424,47	-	8	3020	25	75	170	7	65,1	51	7

XH 7/8'' (22,225 mm) ADIMLI TRİGER KASNAKLAR

XH 7/8'' (22,225mm) Pitch Timing Belt Pulleys

Konik Burçlu / With Taper Bush

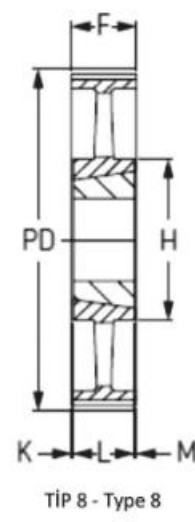
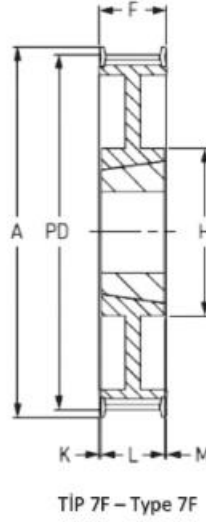
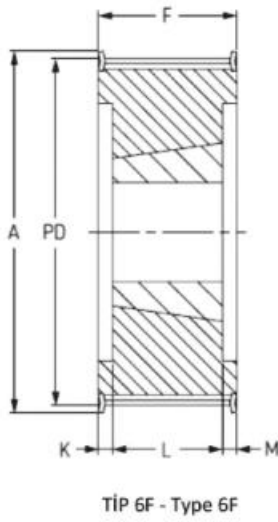

XH 300

Kayış Geniřlięi 76,2mm For Belt Width 76,2

Diř SAYISI No teeth	ÇAP Diameter		TİP Type	BURÇ Bush	DELİK Bore		BOYUTLAR Dimension				
	P.D. mm	A mm			Min. mm	Max. mm	H mm	K mm	F mm	L mm	M mm
18	127,34	141	6F	2012	14	50	-	-	92,1	32	-
19	134,41	146	6F	2517	16	60	-	-	92,1	45	-
20	141,49	155	6F	2517	16	60	-	-	92,1	45	-
21	148,56	169	6F	2517	16	60	-	-	92,1	45	-
22	155,64	169	6F	2517	16	60	-	-	92,1	45	-
24	169,79	183	6F	2517	16	60	-	-	92,1	45	-
25	176,86	198	6F	2517	16	60	-	-	92,1	45	-
26	183,93	198	6F	2517	16	60	-	-	92,1	45	-
27	191,01	212	6F	2517	16	60	-	-	92,1	45	-
28	198,09	212	7F	2517	16	60	120	23,5	92,1	45	23,5
30	212,23	226	7F	2517	16	60	120	23,5	92,1	45	23,5
32	226,38	240	7F	3020	25	75	170	20,5	92,1	51	20,5
36	254,64	267	7F	3020	25	75	170	20,5	92,1	51	20,5
40	282,98	-	8	3020	25	75	170	20,5	92,1	51	20,5
48	339,57	-	8	3020	25	75	170	20,5	92,1	51	20,5
60	424,47	-	8	3020	25	75	170	20,5	92,1	51	20,5